

Panasonic®

Advanced Hybrid System

User Guide for KX-T77 Series



Model No. **KX-TA824**



































Please read this guide before using and save for future reference.

Document Version: 2006-05















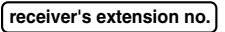







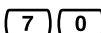



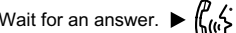

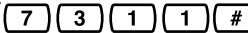
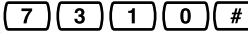
Features List

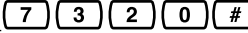
 Outside (CO) Line button
  Programmable Feature button
  Feature number



 Off-hook
  On-hook
  Talk
 * "Location of Controls" is shown on pages 8-9.

Desired Feature	Operation
Making Calls	
Calling	<p>To an extension</p>  ►  / extension no. ► 
Redial	 ►  ► 
One-touch Dialing	<p>To program</p>  ►  2 /  ► desired no. ►  ► 
	<p>To dial</p>  ►  /  ► 
Calling an operator	 ►  ► 
Speed Dialing (Personal)	<p>To store</p>  ►  * ► personal speed dial no. (0-9) ► desired no. ►  ► 
	<p>To dial</p>  ►  ► personal speed dial no. (0-9) ► 
Speed Dialing (System)	<p>To dial</p>  ►  ► system speed dial no. (00-99) ► 
Receiving Calls	
Hands-free answerback (Other than KX-T7750)	<p><i>While on-hook</i></p> 
Picking up a call	<p>Directed</p>  ►  ► extension no. ► 

Features List

Desired Feature	Operation	
When the Dialed Extension is Busy/No Answer		
Automatic Callback Busy	To set <i>While hearing a busy tone</i> 	To call <i>If you hear callback ringing</i> 
Message Waiting	Sender	To leave a notification   <hr/> To cancel a notification     
	Receiver	To call back    <hr/> To clear all notifications    
Call Waiting	Sender	<i>While hearing a busy tone</i>  
	Receiver	 <div style="border: 1px dashed black; padding: 10px; display: inline-block; margin: 10px;"> <p>For outside calls</p> <p> Set</p> <p> Cancel</p> <p>For intercom calls/doorphone calls</p> <p> Set</p> <p> Cancel</p> </div>  <hr/> To talk to the new party <i>While hearing the Call Waiting tone</i> Terminating a current status  /   <hr/> Holding a current status   /  

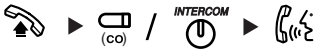
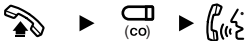
Features List

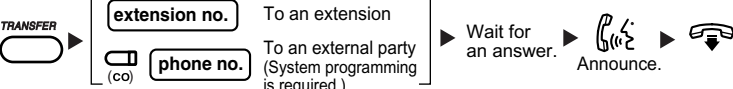
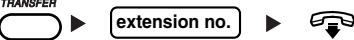
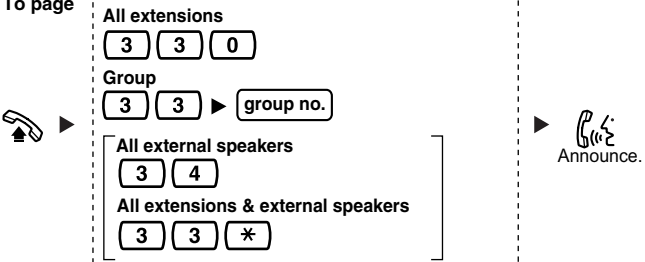
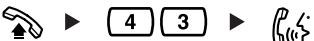
Desired Feature	Operation
During a Conversation	
Holding a call	<p>Holding</p>  <p>To retrieve a call at the holding extension</p> 
	<p>To retrieve an outside call from another extension</p> 
Holding a call exclusively	<p>Holding</p> 
	<p>To retrieve a call on exclusive hold</p> 
Transferring a call	<p>Screened</p>  <p>To an extension</p> <p>To an external party (System programming is required.)</p>
	<p>Unscreened to an extension</p> 
Useful Features	
Paging	<p>To page</p>  <p>All extensions 3 3 0</p> <p>Group 3 3 group no.</p> <p>All external speakers 3 4</p> <p>All extensions & external speakers 3 3 *</p>
	<p>To answer an announced page</p> 

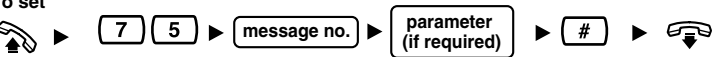
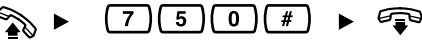
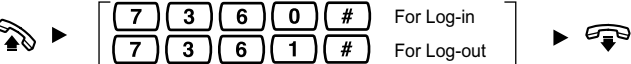
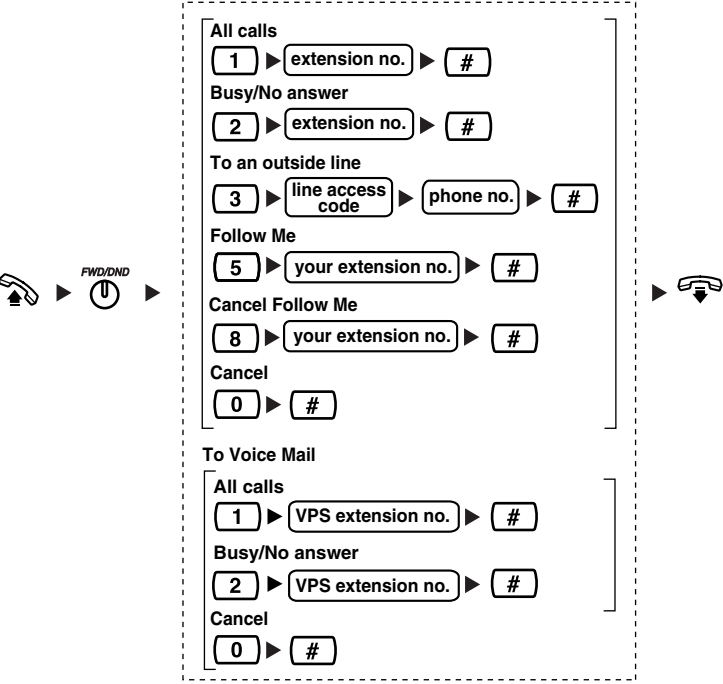

Features List

Desired Feature	Operation
Useful Features	
Three-party conference	
Setting Absent Message	<p>To set</p>  <hr style="border-top: 1px dashed black;"/> <p>To cancel</p> 
Log-in/Log-out	
Forwarding a call	

Features List

Desired Feature	Operation
Useful Features	
Do Not Disturb (DND)	
Locking your extension	<p>(Lock code is 4 digits.)</p>
Clearing the setting	

Features List

Desired Feature	Operation	
Making Use of the Voice Mail Service		
Listening to a message	From your own extension	 ▶ <input data-bbox="505 293 647 325" type="text" value="VPS extension no."/> ▶ ▶ <input data-bbox="460 352 602 384" type="text" value="VPS password"/> <input data-bbox="613 352 647 384" type="text" value="#"/> <ul style="list-style-type: none"> • If you have no password, you can skip the last step.
	From someone else's extension	 ▶ <input data-bbox="505 552 647 584" type="text" value="VPS extension no."/> ▶ ▶ <input data-bbox="460 611 493 643" type="text" value="#"/> <input data-bbox="505 611 538 643" type="text" value="6"/> ▶ <input data-bbox="583 611 617 643" type="text" value="*"/> ▶ ▶ <input data-bbox="426 668 580 700" type="text" value="mailbox no."/> ▶ ▶ <input data-bbox="449 726 591 758" type="text" value="VPS password"/> <input data-bbox="602 726 636 758" type="text" value="#"/> <ul style="list-style-type: none"> • If you have no password, you can skip the last step.
Leaving a message	 ▶ <input data-bbox="393 978 535 1010" type="text" value="VPS extension no."/> ▶ <input data-bbox="580 978 613 1010" type="text" value="#"/> <input data-bbox="636 978 669 1010" type="text" value="6"/> ▶ ▶ <input data-bbox="337 1035 449 1067" type="text" value="mailbox no."/> / <input data-bbox="490 1035 524 1067" type="text" value="#"/> <input data-bbox="557 1035 591 1067" type="text" value="1"/> ▶ Enter the first 3 or 4 letters of the desired name ▶ ▶ Leave a message	
During playback	<input data-bbox="295 1157 329 1189" type="text" value="0"/> Repeat Voice Guidance <input data-bbox="295 1204 329 1236" type="text" value="*"/> Exit Menu	

- KX-TVA series**
 - Listen to Message
 - Deliver Message
 - Mailbox Management
 - Automated Attendant
 - Message Notification
 - Other Features
 - End Call
- KX-TVS series**
 - Listen to Message
 - Deliver Message
 - Check Mailbox Distribution
 - Automated Attendant
 - Mailbox Management
 - Other Features
 - End Call

Location of Controls



RINGER Volume/BACKLIGHT Illumination/Talking Caller ID Selector

LCD (Liquid Crystal Display) with Backlight

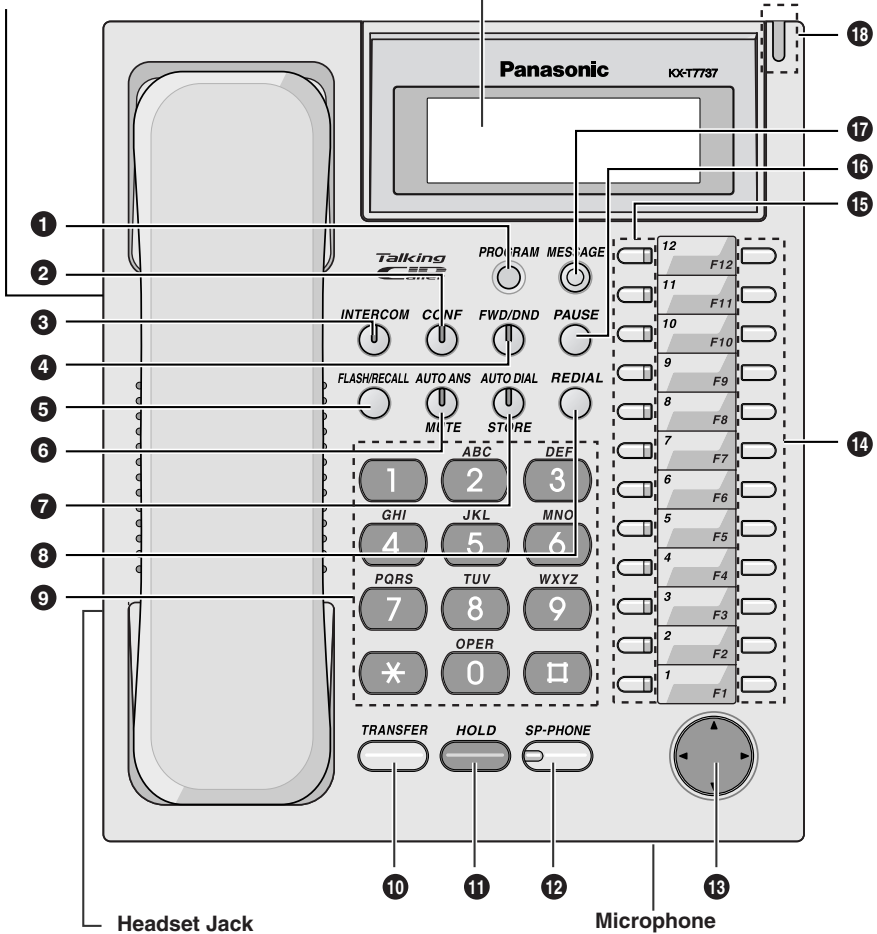

- * The KX-T7750 does not have a microphone.
- * The backlit display is only available on the KX-T7730/7731/7735/7736/7737.
- * The use of a headset is optional. Recommended headsets are KX-TCA91 and KX-TCA92.
- * The Talking Caller ID Selector is only available on the KX-T7737.

Location of Controls

- 1 PROGRAM:** Used to enter and exit the programming mode.
- 2 CONF (Conference):** Used to establish a multiple party conversation.
- 3 INTERCOM:** Used to make or receive intercom calls.
- 4 FWD/DND (Call Forwarding/Do Not Disturb):** Used to perform Call Forwarding or Do Not Disturb.
- 5 FLASH/RECALL:** Used for External Feature Access or to disconnect the current call and make another call without hanging up.
- 6 AUTO ANS (Auto Answer) (Other than KX-T7750):** Used to answer an incoming call in the hands-free mode.
MUTE (Other than KX-T7750): Used to mute the microphone during a conversation.
VOICE CALL (KX-T7750 only): Used to receive a notification via monitor in place of ringing.
- 7 AUTO DIAL/STORE:** Used for speed dialing or storing program changes.
- 8 REDIAL:** Used to redial.
- 9 DIALING BUTTONS WITH BACKLIGHT (KX-T7731/7736/7737):** Dialing buttons are backlit (1) when you receive a call, (2) during a conversation, (3) when BGM is activated at your phone, or (4) when you press any button.
- 10 TRANSFER:** Used to transfer a call to another party.
- 11 HOLD:** Used to place a call on hold.
- 12 SP-PHONE (Other than KX-T7750):** Used for the hands-free operation.
MONITOR (KX-T7750 only): Used for hands-free dialing. You can monitor the other party's voice hands-free.
- 13 NAVIGATOR KEY (KX-T7730/7731/7735/7736/7737):** Used to adjust the volume and the display contrast, or select desired items.
VOLUME KEY (KX-T7720/7750): Used to adjust the volume.
- 14 Programmable Feature (PF) Button:** Used as a One-touch Dialing button. (Button assignment is required.)
- 15 Flexible Outside (CO) Line Button:** Used to make or answer an outside call. Pressing this button seizes an idle outside line automatically. (Button assignment is required.) Also used as a feature button. (Button assignment is required.)
- 16 PAUSE:** Used to insert a pause during dialing.
- 17 MESSAGE:** Used to leave a message waiting indication, or call back the party who left the message waiting indication.
- 18 Message/Ringer Lamp:** The Message/Ringer lamp informs you visually that you have a message or a call.
 - When you receive a call, the lamp flashes depending on the ringing pattern. When the ringing pattern is set to Single (Slow flash), Double (Moderate flash), or Triple (Rapid flash) in your PBX, the lamp flashes accordingly. When any of the other ringing patterns are set in your PBX, the lamp may not flash. (e.g., S-Double, Call Waiting Tone1.)
 - When someone has left you a message, the lamp is lit continuously.

Before Operating the Telephone

◆ Speaker/Handset/Headset volume *

Speaker volume While in hands-free conversation	
Handset/Headset volume While using the handset or headset	

Press **Up** (Level increases) or **Down** (Level decreases).

◆ Ringer volume/Backlight illumination



RINGER



BACKLIGHT

Slide the lever of the **RINGER** Volume Selector and **BACKLIGHT** Illumination Selector to the desired setting.

BACKLIGHT SW POSITION	2	1	0
LCD backlight	HIGH	LOW	OFF
DIALING BUTTONS backlight	AUTO	AUTO	OFF

AUTO: The backlight shines only during operation.

◆ Display contrast *

KX-T7730/7731/7735/7736/7737



Press **Left** (Light) or **Right** (Dark).

* The above settings may return to default settings if the telephone line cord is disconnected, or the main unit's power is interrupted.

Before Operating the Telephone

◆ Talking Caller ID

KX-T7737

You can hear Caller ID information vocally sent from your PBX through the built-in speaker. The voice volume of Talking Caller ID depends on the setting of the Ringer volume. For the Ringer volume, refer to "**Ringer volume**" on page 10.



Slide the **TALK CID** Selector to ON to enable the Talking Caller ID feature.

Note: If the character ":" is included in the Caller ID name, it will not be announced normally. Therefore, we recommend that you do not use ":" in the Caller ID name.

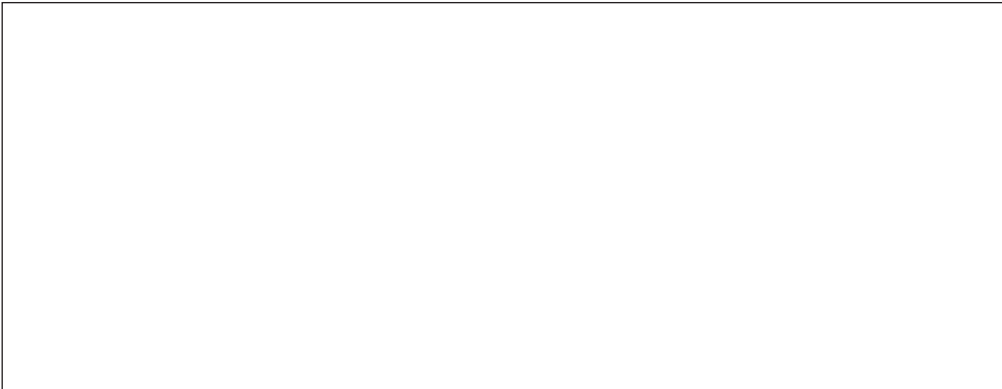

Panasonic Consumer Electronics Company,
Division of Panasonic Corporation of North America
One Panasonic Way, Secaucus, New Jersey 07094

Panasonic Puerto Rico, Inc.
San Gabriel Industrial Park, Ave. 65 de Infantería, Km. 9.5,
Carolina, Puerto Rico 00985

<http://www.panasonic.com/csd>

© 2005 Panasonic Communications Co., Ltd. All Rights Reserved.

PSQX3422WA KK0405ST3056